

- Up To 10 off SP4T in a Single Module
- 1.8 GHz Switching (SMB Version)
- 1.3 GHz Switching (Multiway Version)
- SMB and Multiway Connector Versions
- Low Cost, High Performance
- VISA, IVI & Kernel Drivers Supplied for Windows
- Supported by PXI or LXI Chassis
- Supported by **eBIRST™**
- 3 Year Warranty



The 40-755 is a 50 Ω high density RF multiplexer available with up to 10xSP4T switches in a single PXI module. It is available with two connector options; SMB that provides a frequency range of 1.8 GHz, or multiway which limits the bandwidth to 1.3 GHz but offers a high density solution occupying one PXI slot. The connectors used are fully supported by the range of Pickering Interfaces connection solutions.

40-755 50 Ω RF Multiplexer Range:	
10 off SP4T, 1.8GHz, SMB Connector, Dual PXI Slot	
10 off SP4T, 1.3GHz, Multiway Connector, Single PXI Slot	
5 off SP4T, 1.3GHz, Multiway Connector, Single PXI Slot	
4 off SP4T, 1.8GHz, SMB Connector, Single PXI Slot	

The module offers low insertion loss and low VSWR through its usable frequency range and each multiplexer has been designed to have path independent loss.

The array of SP4T switches can be connected into alternative configurations through the use of external cabling.

The 40-755 is supplied with drivers that allow the user to support the module in all popular PXI software environments. In addition, the module can be supported in all Pickering's LXI Modular Chassis, allowing the use of a PXI or LAN controlled switching solution with the same high levels of performance.

Supported by eBIRST

SMB builds of this product are supported by the eBIRST switching system test tools which simplify switching system fault-finding by quickly testing the system and graphically identifying the faulty relay.

For more information go to: pickeringtest.com/ebirst

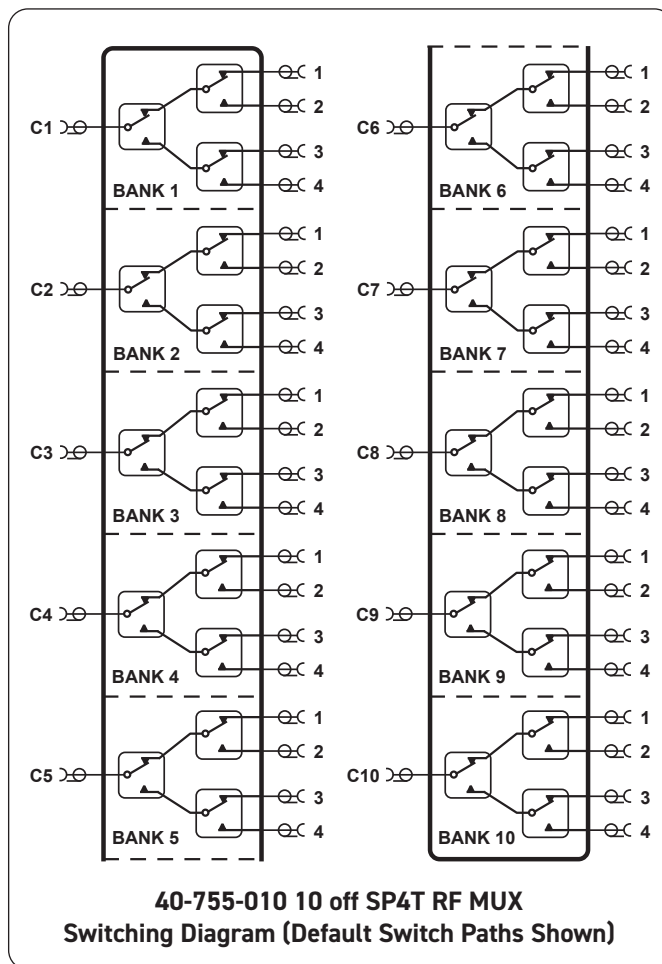

40-755 Specification with Multiway Connectors

RF Specification - Multiway Connector Versions

Impedance:	50 Ω
RF Frequency Range:	DC to 1.3 GHz
Insertion Loss:	<1 dB to 500 MHz (typically 0.7 dB) 2.5 dB to 1.3 GHz (typically 2.0 dB)
VSWR:	<1.8:1 to 500 MHz (typically 1.5:1 max) 3.2:1 to 1.3 GHz (typically 2.8:1)
Isolation:	>50 dB to 1.3 GHz (typically >55 dB)
Crosstalk:	<-50 dB to 1.3 GHz (typically <-55 dB)
Maximum RF Power:	10 W at 1.3 GHz

Other Switching Specification

Maximum Hot Switch Voltage:	200 VDC or AC peak
Maximum Hot Switch Current:	1 A
Maximum Cold Switch Current:	1 A
Maximum Hot Switch Power:	10 W
Operating Time:	3 ms typical
Life Expectancy:	10 million operations at <100 mW



40-755-010 10off SP4T RF MUX with MS-M RF multiway connectors

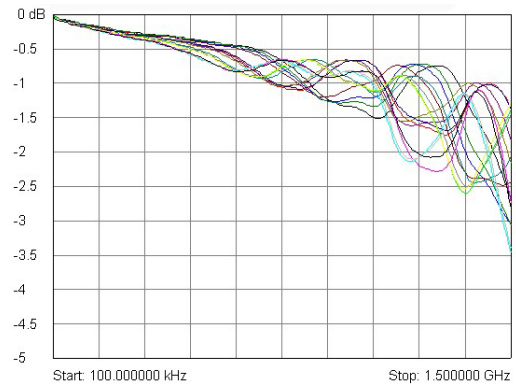

40-755 typical insertion loss plot

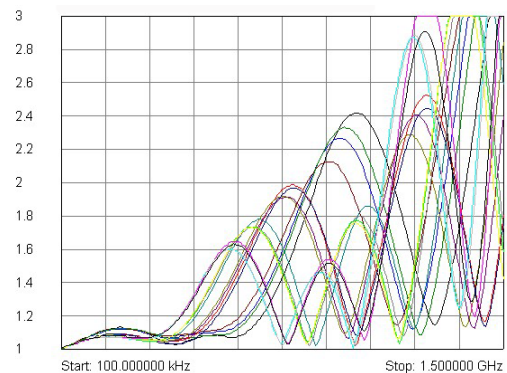

40-755 typical VSWR plot

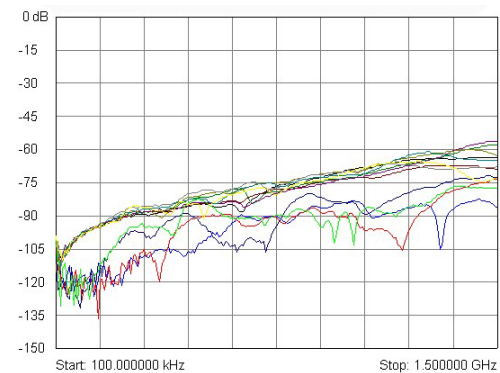

40-755 typical bank to bank crosstalk plot

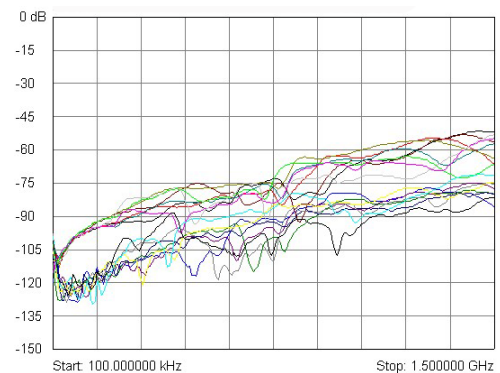

40-755 typical channel to common isolation plot

40-755 Specification with SMB Connectors

RF Specification - SMB Connector Versions

Impedance:	50 Ω
RF Frequency Range:	DC to 1.8 GHz
Insertion Loss:	<1.3 dB to 1.8 GHz (typically 0.8 dB)
VSWR:	<1.6:1 to 1.8 GHz
Isolation:	>40 dB to 1.8 GHz
Crosstalk:	<-40 dB to 1.8 GHz
Maximum RF Power:	10 W at 1.8 GHz

Other Switching Specification

Maximum Hot Switch Voltage:	200 VDC or AC peak
Maximum Hot Switch Current:	1 A
Maximum Cold Switch Current:	1 A
Maximum Hot Switch Power:	10 W
Operating Time:	3 ms typical
Life Expectancy:	10 million operations at <100 mW



40-755-110 10off SP4T RF MUX with SMB coaxial connectors

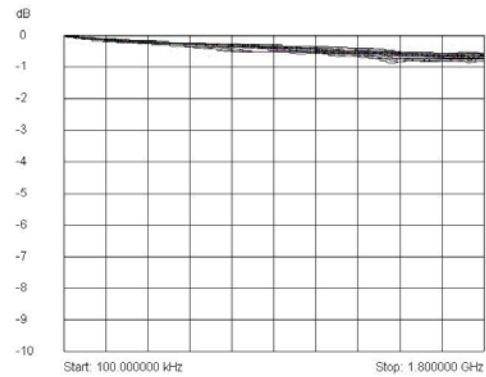

40-755 typical insertion loss plot

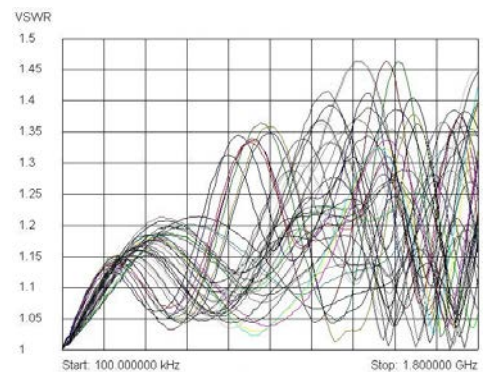

40-755 typical VSWR plot

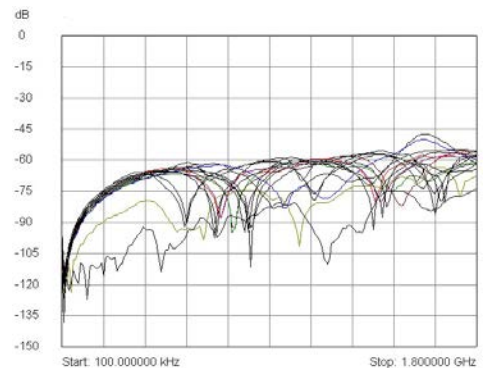

40-755 typical bank to bank crosstalk plot

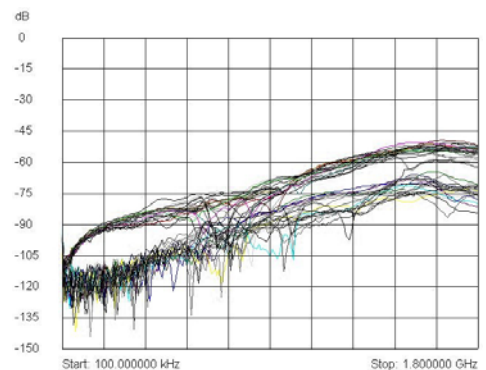

40-755 typical channel to common isolation plot

Power Requirements

+3.3V	+5V	+12V	-12V
1 A	0.65 A	0	0

Mechanical Characteristics

Single slot 3U PXI (CompactPCI card).

- 40-755-005/010/104 Single slot 3U PXI (CompactPCI card)
- 40-755-110 Dual slot 3U PXI (CompactPCI card)

3D models for all versions in a variety of popular file formats are available on request.

Connectors

PXI bus via 32-bit P1/J1 backplane connector.

Signals via front panel RF connectors:

- 40-755-005 1off high density male 26-pin MS-M RF multi-way connector
- 40-755-010 2off high density male 26-pin MS-M RF multi-way connector
- 40-755-104 20off SMB coaxial connectors
- 40-755-110 50off SMB coaxial connectors

For pin outs please refer to the operating manual.

Operating/Storage Conditions

Operating Conditions

Operating Temperature: 0°C to +55°C
 Humidity: Up to 90% non-condensing
 Altitude: 5000 m

Storage and Transport Conditions

Storage Temperature: -20°C to +75°C
 Humidity: Up to 90% non-condensing
 Altitude: 15000 m

PXI & CompactPCI Compliance

The module is compliant with the PXI Specification 2.2. Local Bus, Trigger Bus and Star Trigger are not implemented.

Uses a 33MHz 32-bit backplane interface.

Safety & CE Compliance

All modules are fully CE compliant and meet applicable EU directives: Low-voltage safety EN61010-1:2010, EMC Immunity EN61326-1:2013, Emissions EN55011:2009+A1:2010.



40-755-104 4off SP4T RF MUX with SMB coaxial connectors

Product Order Codes

10off SP4T RF MUX, 1.3 GHz Multiway	40-755-010
5off SP4T RF MUX, 1.3 GHz Multiway	40-755-005
10off SP4T RF MUX, 1.8 GHz SMB	40-755-110
4off SP4T RF MUX, 1.8 GHz SMB	40-755-104

Product Customization

Pickering modules are designed and manufactured on our own flexible manufacturing lines, giving complete product control and enabling simple customization to meet very specific requirements.

All customized products are given a unique part number, fully documented and may be ordered at any time in the future. Please contact your local sales office to discuss.

Support Products

eBIRST Switching System Test Tool

SMB builds of this product is supported by the eBIRST test tools which simplify the identification of failed relays, the required eBIRST tools are below. For more information go to: pickeringtest.com/ebirst

Product	Test Tool	Adaptor
40-755-110/104	93-005-001	93-005-202A
40-755-010/005	Unsupported	

Spare Relay Kits

Kits of replacement relays are available for the majority of Pickering's PXI switching products, simplifying servicing and reducing down-time.

Product	Relay Kit
40-755	91-100-014

For further assistance, please contact your local Pickering sales office.

Mating Connectors & Cabling

For connection accessories for the SMB version of the 40-755 please refer to the [90-011D](#) RF Cable Assemblies data sheet, or for the multiway MS-M connector version please refer to the [90-017D](#) Cable Assemblies where a complete list and documentation can be found for accessories, or refer to the Connection Solutions catalog.

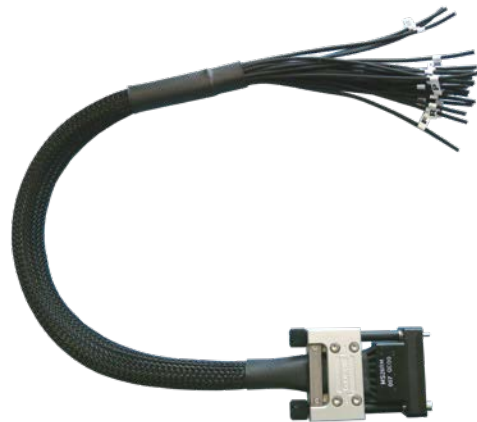

Pickering can supply cable assemblies for all its modules. The cable shown (MS-M RF to unterminated coax) is suitable for multiway connector versions of the 40-755.

Chassis Compatibility

This PXI module must be used in a suitable chassis. It is compatible with the following chassis types:

- All chassis conforming to the 3U PXI and 3U Compact PCI (cPCI) specification
- Legacy and Hybrid Peripheral slots in a 3U PXI Express (PXIe) chassis
- Pickering Interfaces LXI or LXI/USB Modular Chassis

Chassis Selection Guide

Standard PXI or hybrid PXIe Chassis from any Vendor:

- Mix our 1000+ PXI switching & simulation modules with any vendor's PXI instrumentation
- Embedded or remote Windows PC control
- Real-time Operating System Support
- High data bandwidths, especially with PXI Express
- Integrated module timing and synchronization



Pickering LXI or LXI/USB Modular Chassis—only accept our 1000+ PXI Switching & Simulation Modules:

- Ethernet or USB control enables remote operation
- Low-cost control from practically any controller
- LXI provides manual control via Web browsers
- Driverless software support
- Power sequencing immunity
- Ethernet provides chassis/controller voltage isolation
- Independence from Windows operating system



Connectivity Solutions

We provide a full range of supporting cable and connector solutions for all our switching products—20 connector families with 1200+ products. We offer everything from simple mating connectors to complex cables assemblies and terminal blocks. All assemblies are manufactured by Pickering and are guaranteed to mechanically and electrically mate to our modules.



Connectors & Backshells



Multiwire Cable Assemblies



RF Cable Assemblies



Connector Blocks

We also offer customized cabling and have a free online **Cable Design Tool** that can be used to create custom cable solutions for many applications.

Visit: pickeringtest.com/cdt to start your design.

Mass Interconnect

We recommend the use of a mass interconnect solution when an Interchangeable Test Adapter (ITA) is required for a PXI or LXI based test system. Our modules are fully supported by both Virginia Panel and MacPanel.

Pickering Reed Relays

We are the only switch provider with in-house reed relay manufacturing capability via our Relay Division. These instrument grade reed relays feature **SoftCenter™** technology, ensuring long service life and repeatable contact performance. To learn more, please go to: pickeringrelay.com



Programming

Pickering provide kernel, IVI and VISA (NI & Keysight) drivers which are compatible with all Microsoft supported versions of Windows and popular older versions. For a list of all supporting operating systems, please see: pickeringtest.com/os

The VISA driver is also compatible with Real-Time Operating Systems such as LabVIEW RT. For other RTOS support contact Pickering. These drivers may be used with a variety of programming environments and applications including:

- **Pickering Interfaces Switch Path Manager**
- **National Instruments** products (LabVIEW, LabWindows/CVI, Switch Executive, MAX, TestStand, VeriStand, etc.)
- **Microsoft Visual Studio** products (Visual Basic, Visual C+)
- **Keysight** VEE and OpenTAP
- **Mathworks** Matlab
- **Marvin** ATEasy
- **MTQ Testsolutions** Tecap Test & Measurement Suite

Drivers for popular Linux distributions are available, other environments are also supported, please contact Pickering with specific enquiries. We provide Soft Front Panels (SFPs) for our products for familiarity and manual control, as well as comprehensive documentation and example programs to help you develop test routines with ease.

To learn more about software drivers and development environments, please go to: pickeringtest.com/software

Signal Routing Software

Our signal routing software, Switch Path Manager, automatically selects and energizes switch paths through Pickering switching systems. Signal routing is performed by simply defining test system endpoints to be connected together, greatly accelerating Test System software development. To learn more, please go to: pickeringtest.com/spm

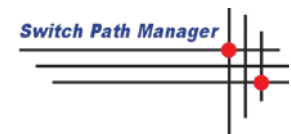

Diagnostic Relay Test Tools

eBIRST Switching System Test Tools are designed specifically for our PXI, PCI or LXI products, these tools simplify switching system fault-finding by quickly testing the system and graphically identifying the faulty relay.

To learn more, please go to: pickeringtest.com/ebirst



Three Year Warranty & Guaranteed Long-Term Support

All standard products manufactured by Pickering Interfaces are warranted against defective materials and workmanship for a period of three years from the date of delivery to the original purchaser. Extended warranty and service agreements are available for all our modules and systems with various levels to suit your requirements. Although we offer a 3-year warranty as standard, we also include guaranteed long-term support—with a history of supporting our products for typically 15-20 years. To learn more, please go to: pickeringtest.com/support

Available Product Resources

We have a large library of product resources including success stories, product and support videos, articles and white papers as well as application specific product brochures to assist when looking for the switching, simulation and connection solutions you need. We have also published handy reference books on Switching Technology and for the PXI and LXI standards.



To view, download or request any of our product resources, please visit: pickeringtest.com/resources